

divano/sofa **Stewart**

elementi/elements

designed by Castello Lagravinese



Struttura portante: Multistrato, massello di legno.

Imbottiture: Cuscino di schienale in piuma d'oca e particelle di fibra di poliestere; cuscino di seduta in poliuretano espanso a densità differenziata; Scocca in poliuretano espanso a densità differenziata, rivestito in resinato 200 gr e tela di cotone.

Molle: Cinghie elastiche in polipropilene e gomma.

Basamento: Zoccolo in lamina di metallo su supporto in MDF.

Main structure: Solid and multilayer wood.

Upholstery: Back cushion in goose feathers and polyester fiber chips; seat cushion in polyurethane foam with different densities; Chassis in polyurethane foam with different densities, covered with resinate 200 grams and cotton fabric.

Suspensions: Elastic belts in polypropylen and rubber.

Basement: MDF basis metal laminated.

Cod. Pelle/leather: 2/02

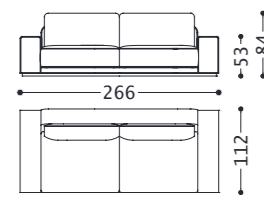
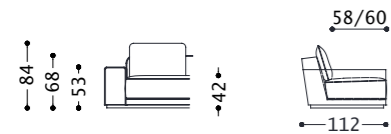

2STWD3MSP

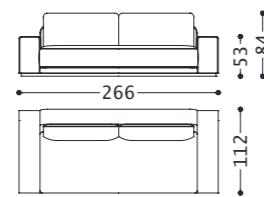

2STWD3M

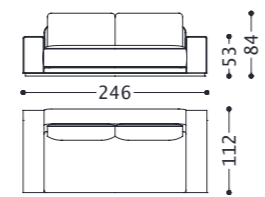

2STWD3

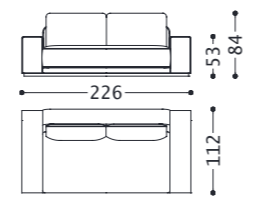

2STWD2M

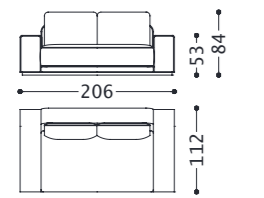

2STWD2

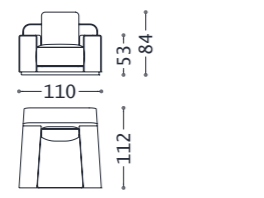

2STWP

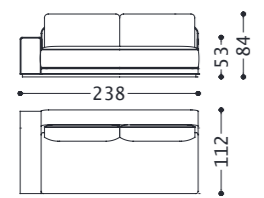

2STWD3MSX

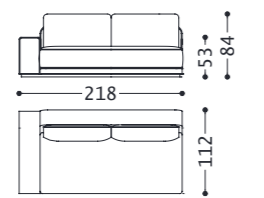

2STWD3SX

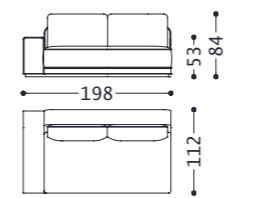

2STWD2MSX

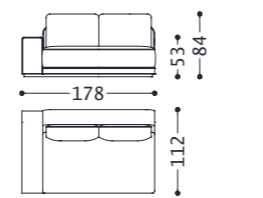

2STWD2SX

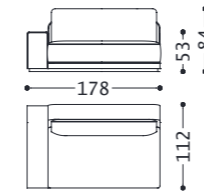

2STWD2SPSX

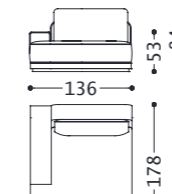

2STWDORMSX

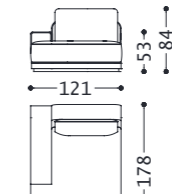

2STWDORMSX

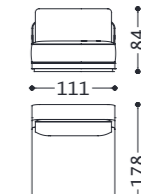

2STWCHL

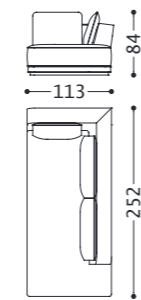

2STWMERSX

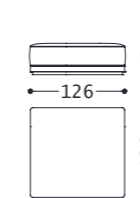

2STWPQG

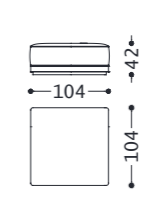

2STWPQP

divano/sofa **Stewart**

composizioni/compositions

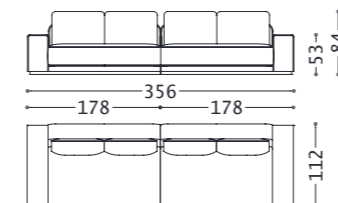

02STWC1
(2STWD2SX-2STWD2DX)

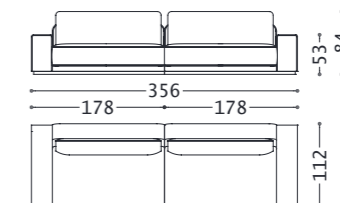

02STWC4
(2STWD2SPSX-2STWD2SPDX)

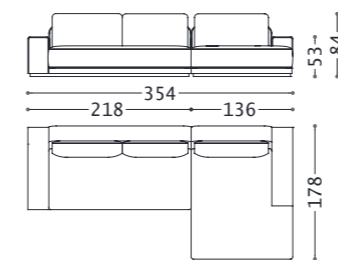

02STWC3
(2STWD3SX-2STWDORMDX)

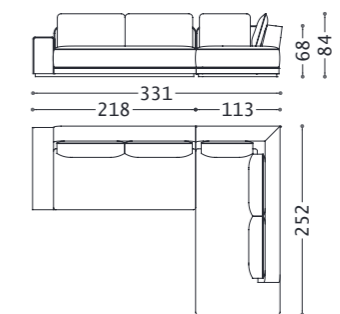

02STWC2
(2STWD3SX-2STWMERDX)